

Tech Reference: Instruments

do
you
need
more
information?

The following section addresses technical questions often asked about instruments. It is organized alphabetically by type of instrument.

All Troubleshooting information shown, as well as Installation Instructions, are available for download/printing at www.teleflexmarine.com. If you require further assistance, please contact Teleflex Marine Tech Service as noted below.

*For Technical Support of
Teleflex Electrical Products,
contact:*

Teleflex Electrical Systems
6980 Professional Parkway East
Sarasota, FL 34240
Phone: 941-907-1000, ext. 8222
FAX: 941-907-1020
www.teleflexmarine.com

Teleflex Marine Instruments

Instrument Dimensions

A - Bezel Diameter
 B - Gauge Housing Diameter
 C - Distance from Back Edge of Bezel to End of Longest Stud
 D - Bezel and Lens Combined Protrusion from Dash
 (All dimensions are shown in inches.)

GAUGE LINE/ TYPE	"A" DIM.	"B" DIM.	"C" DIM.	"D" DIM.
PRO SERIES & SIGNATURE SERIES:				
2" All Electrical Gauges	2.38	2.13/2.16	2.50	.38
2" Mechanical Pressure Gauges	2.38	2.13/2.16	2.50	.38
3" Electric Tachometers	3.78	3.41/3.44	2.76	.58
3" Electric Tach/Hourmeters	3.78	3.41/3.44	3.88	.58
3" Marine Pitot-Type Speedos	3.78	3.41/3.44	2.70	.58
VALUE SERIES-HEAVY DUTY:				
2" All Electrical Gauges	2.38	2.13/2.16	2.14	.22
2" Mechanical Pressure/Vacuum	2.26	2.13/2.16	2.04	.30
2" Mechanical Temperature	2.26	2.13/2.16	3.00	.30
3" Electric Tachometers	3.78	3.41/3.44	2.75	.34
3" Programmable Tachometers	3.78	3.41/3.44	3.74	.34
3" Marine Pitot-Type Speedos	3.78	3.41/3.44	2.70	.34
VALUE SERIES-RED INTERNATIONAL:				
2" All Electrical Gauges	2.45	2.13/2.16	2.50	.44
2" Mechanical Pressure Gauges	2.45	2.13/2.16	2.50	.44
3" Electric Tachometers	3.88	3.41/3.44	2.76	.67
3" Electric Tach/Hourmeters	3.88	3.41/3.44	3.88	.67
3" Marine Pitot-Type Speedos	3.88	3.41/3.44	2.70	.67
3" Marine Electric Speedos	3.88	3.41/3.44	2.76	.67
VALUE SERIES-SPORTSMAN:				
2" All Electrical Gauges	2.46	2.13/2.16	2.50	.25
2" Mechanical Pressure Gauges	2.46	2.13/2.16	2.50	.25
3" Electric Tachometers	3.85	3.41/3.44	2.76	.25
3" Marine Pitot-Type Speedos	3.85	3.41/3.44	2.70	.25
3" Marine Electric Speedos	3.85	3.41/3.44	2.76	.25
VALUE SERIES-VECTOR:				
2" All Electrical Gauges	2.45	2.13/2.16	2.50	.44
2" Mechanical Pressure Gauges	2.45	2.13/2.16	2.50	.44
3" Electric Tachometers	3.88	3.41/3.44	2.76	.67
3" Electric Tach/Hourmeters	3.88	3.41/3.44	3.88	.67
3" Marine Pitot-Type Speedos	3.88	3.41/3.44	2.70	.67
3" Marine Electric Speedos	3.88	3.41/3.44	2.76	.67
UNIV. SPECIALTY GAUGES:				
2" Universal Round Hourmeter	2.27	2.00/2.06	2.4	.33
2" Univ. Rectangular Hourmeter	2.1x1.2	1.7x.96	2.3	.20

TYPICAL GAUGE DIMENSIONS:

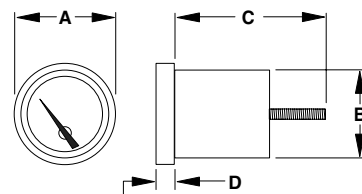
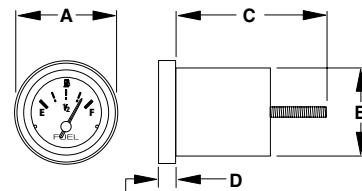
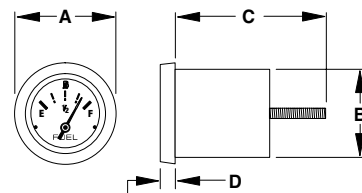
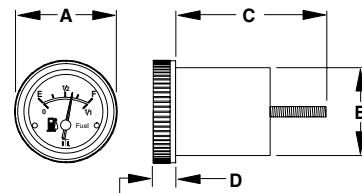
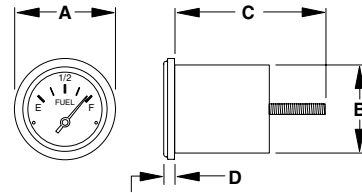
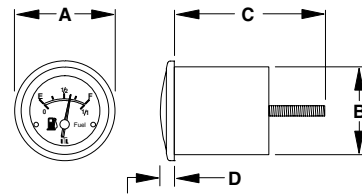

NOTE: When selecting mechanical gauges, allow room for hose, tubing or cable connection in addition to the above "C" dimensions. Dimensions shown are subject to change.

Specifications:

Operating Temperature Range:

-40°F to +185°F, with a $\pm 2\%$ of full scale reading change (max.) to 75°F indication for all Teleflex gauges.

Shock Withstand:

Teleflex instruments remain within initial accuracy specification up to 50 G's, half-sine 9-13 milliseconds duration, 25 shocks of equal magnitude in each of three axes.

Vibration Withstand:

Teleflex instruments stay within initial accuracy specification at .060" double amplitude vibration from 10-80-10 Hz for one minute periods over three hours in each of 3 axes (six hours total).

Humidity:

Teleflex instruments remain within initial accuracy specification in 95% humidity at 100°F (37.8°C) for 48 hours.

Overvoltage:

Teleflex 12-volt instruments withstand a maximum of 18 volts DC applied to the +14 terminal with no damage.

Reverse Polarity Protection:

Reverse polarity protection is designed into all Teleflex instruments.

Voltage Variance:

Accuracy remains within $\pm 2\%$ of initial reading at 14.5 volts DC when voltage is varied from 12 to 16 volts.

Salt Spray:

all Teleflex instruments conform to ASTM B 117 after 48 hours of salt spray exposure.

European Standards:

All current production Teleflex analog electrical instruments comply with the EMC requirements directive for sale in Europe.

Why NPT (National Pipe Thread) Threads Aren't What They Measure.

The industry designation for National Pipe Threads comes from the pipe's **inside diameter**. If you measure the outside diameter of a sender pipe thread, it will be considerably larger than the NPT size:

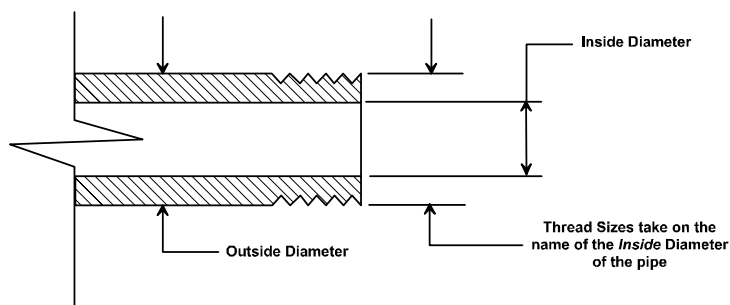

INDUSTRY DESIGNATION	PIPE INSIDE DIAMETER	ACTUAL PIPE OUTSIDE DIAMETER	
1/8-27 NPT	1/8"	.405"	13/32"
1/4-18 NPT	1/4"	.504"	35/64"
3/8-18 NPT	3/8"	.675"	43/67"
1/2-14 NPT	1/2"	.840"	27/32"

Teleflex Marine Instruments

Does The Gauge Work?

To see if the gauge is operating correctly:

1. Remove the gauge's sender wire. Turn on the power. The pointer of whatever gauge you are checking should be at the position shown in the upper portion of the diagram at right.
2. Next, take a short wire and connect to sender terminal and ground terminal (shorting sender terminal to ground).

Gauge pointer should be at the position shown in the lower portion of the diagram.

3. To test senders, the resistance values are shown at minimum and full gauge scales.

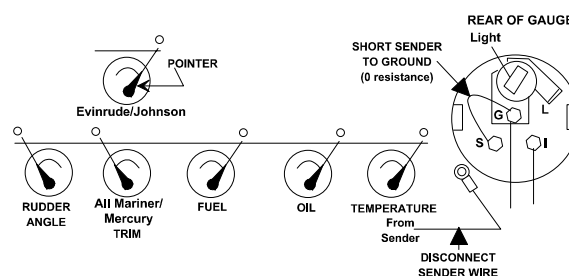
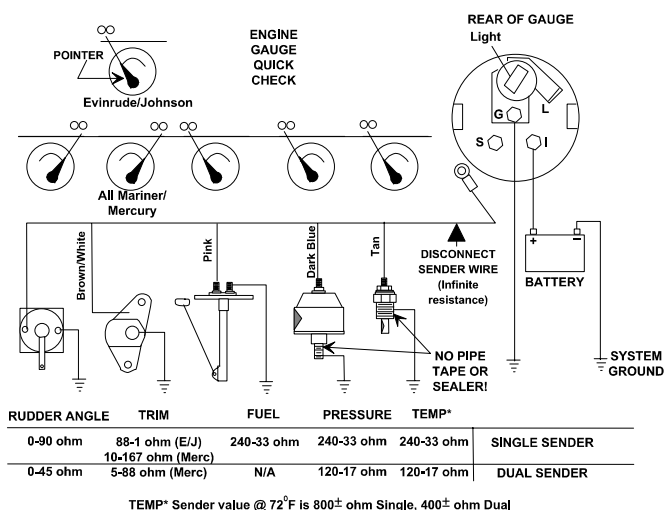

Ammeter —

Direct Reading

1. Be certain all connections are clean and tight. If possible, solder heavy gauge wires to terminal lugs before attaching to the ammeter.
2. If replacing an ammeter, wire to existing connections. If installing an ammeter for the first time, refer to instructions or the diagram at right. The wire connection from the alternator to the starter solenoid must be broken or no current will flow through the ammeter.
3. If the ammeter reads a discharge when it is charging, reverse the heavy gauge wires at the "S" and "I" terminals.
4. Max. current to any Teleflex direct reading ammeter is 60 amperes.
5. Wires must be 10 gauge minimum to ammeter "S" and "I" terminals.
6. Wires for lighting can be 14-18 gauge. A ground for the ammeter is needed only if lighting is used.
7. The red #10 AWG wire from the "S" terminal to the "ACC" post on the ignition switch may be eliminated if a discharge reading is not desired when the ignition accessory is turned on but the engine is not running (i.e. the radio playing).

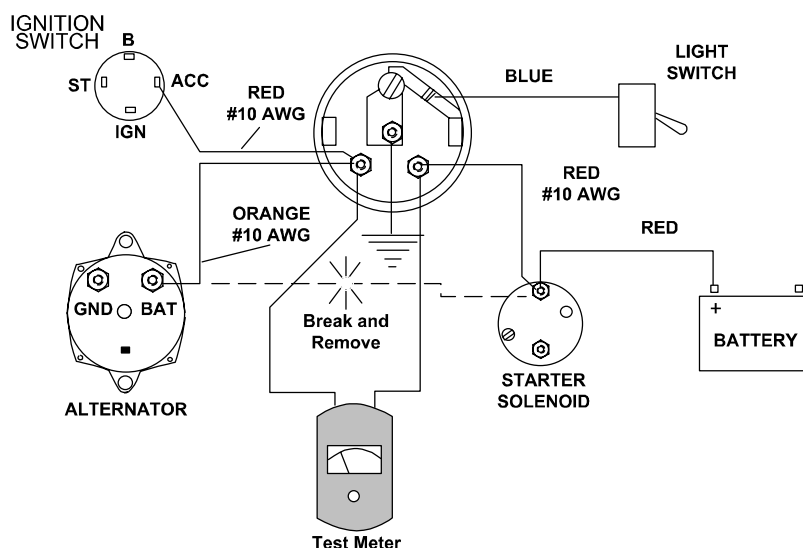

8. The ammeter can be tested with a multimeter (test meter) connected as shown. Remove all connections to the "S" and "I" terminals, taking care not to touch those connections to anything. If the test meter on the ohms scale shows no resistance the ammeter is probably OK. If it shows infinite resistance, the gauge has failed.
9. The part number of the ammeter is stamped on the housing.

Engine Synchronizer

1. Recheck all wire connections to be certain they are clean and tight. Be sure the two plugs are pushed on properly.
2. You must have 12 VDC minimum on the module "IGN" terminal and the "GND" terminal must be grounded.
3. If the gauge on the dash is always "pegged" to port or starboard, the module is usually at fault. It probably will need replacement.
4. The module can be checked by measuring certain voltages while the system is running. Connect a volt-ohm test meter to the dash gauge as shown to either port or starboard side. With both ignitions on (but the engine not running) the test meter should read about 5 volts either side. At 2,000 RPM on starboard engine (0 RPM on port), the meter will read 9 volts on starboard side and 2 volts on port. Repeat the test by swapping actions to the port engine. **NOTE:** All voltages listed are approximate.
5. To check gauge only (Fig. 1), place a 130-ohm 1/2-watt resistor from port or starboard gauge terminal to ground. Connect the gauge ignition terminal to positive voltage source. The pointer will deflect about 45°.
6. System is energized only when ignition switch it is connected to is on.
7. The gauge pointer will point towards the "faster" engine, if wired as shown above. Reversing the "S" and "P" connections at the module will make the synchronizer point to the "slower" engine.
8. In some cases it may be necessary to decrease the sensitivity of the system. This means a greater difference of engine speeds will be required for an equal deflection of the gauge pointer. Loosen the jumpers, swing them out of the way, retighten nuts.
9. One module can operate two gauges, **if the sensitivity jumpers are left in place. Damage to the module will result if they are removed.**
10. The same gauge and harness can be used on various type engines, but the **module must be changed with engine type:**

PART NO. APPLICATIONS

- 1508370P Gasoline stern drive & inboard
- 1504877 Diesel Alternator
- 1507574 Diesel Magnetic Pickup
- 1508473 Diesel Signaflex

11. The gauge can be zeroed by adjusting the module's null potentiometer under the red hole plug (with both ignitions on).

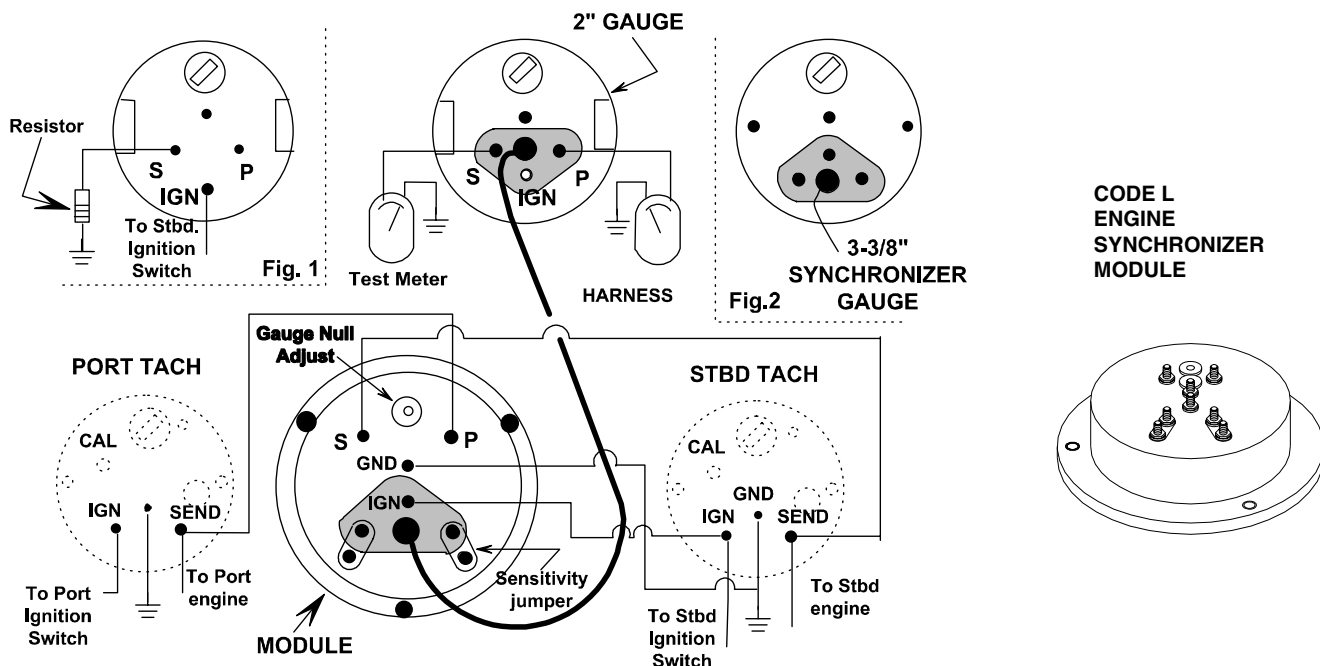

INSTRUMENTS tech reference

Teleflex Marine Instruments

Fuel Systems (Marine)

1. Voltage - "I" to "G" terminal - 10 to 16 volts.
2. Test gauge as follows: Connect "hot" wire to the "I" terminal and ground wire to "G" terminal. Remove sender (usually pink) wire from back of gauge. Gauge should read below "EMPTY." Next, add a short wire from the gauge's "S" (sender) terminal to ground. Gauge should read above "FULL." If the pointer sweeps back and forth, gauge is OK.
3. The sender can be tested by checking its resistance with a volt/ohm test meter (use analog meter) as follows:
 - a. Remove sender (usually pink) wire from sender.
 - b. Connect two test meter wires to two sender terminals (or center terminal & flange if sender has only one terminal).
 - c. Move float arm by hand. Approximate values:
Empty = 240 ohms, 1/2 = 103 ohms,
Full = 33 ohms.
(Teleflex sender: rheostat housing installed upside down will cause gauge to read backwards. See illustration.)
4. Sender resistance tolerances at full may cause the gauge to read 2-3 pointer widths either side of the full mark.
5. The sender will accurately operate only one standard gauge at a time. It is not designed for dual station use with standard gauges.
6. Gauge will not operate accurately from more than one sender at a time. Some installations use a switch to connect one gauge to various tanks, one at a time.

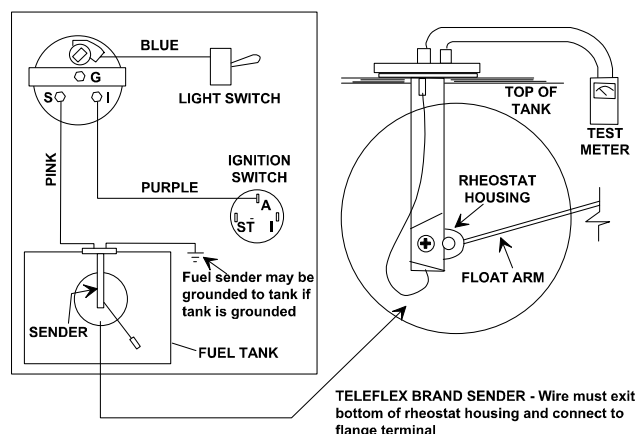

7. Sender will not operate in water tanks. Rheostat will become electrically "open".
8. Be certain sender dimensions are adjusted per the instruction sheet.
9. If sender is "open" (infinite resistance) gauge will read below empty. If sender is shorted (0 resistance) gauge will read above "FULL".
10. Some "bowing" of the flange may occur when the 5 mounting screws are tightened. The gasket under the flange will normally seal the flange properly, but do not overtighten the mounting screws.
11. Sender must be grounded, or gauge will always read "EMPTY."
12. If sender is installed in a tank not designed for a sender, care must be taken to seal screw threads. Sealant under screw head is also advisable. Sealant must withstand gas and diesel fuels.

Hourmeters

1. The hourmeter operates on voltages between 12 and 32 volts DC.
2. The hourmeter's "indicator" wheel (lone window to the right) should index every 3.6 seconds.
3. The hourmeter is not and cannot be lighted.
4. Time recorded cannot be erased or altered backwards.
5. Real time can be added to the hourmeter by connecting it to a power source (12-32 volts). Time added cannot be accelerated.
6. The hourmeter is easy to wire and can be connected to the ignition switch and ground or another gauge's "hot" terminal and ground. The hot side must be switched off when the boat engine is not in use. Be aware that this connection method allows the hourmeter to record time whenever the ignition is on, even when the engine is not running.

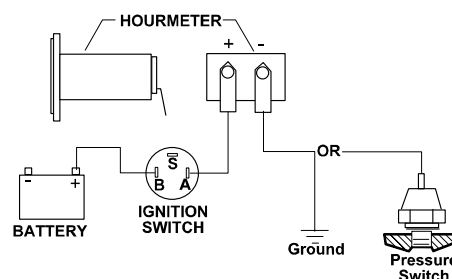

7. There is an alternate wiring method. It requires a pressure switch, normally open ("NO"), 1/8-27 NPT, 6 or 10 PSI is adequate. Instead of wiring the negative side of the hourmeter to ground, wire it to the switch input. The switch must be mounted in an oil pressure port on the engine. When the engine is running the switch will close (complete contact) and allow the hourmeter to ground and operate. In this manner the hourmeter runs only when the engine is running. Not all engines have additional oil pressure ports (outboards do not) that can be used for this purpose.

Oil Pressure System — Inboard & Stern Drive

- To test the gauge, voltage from "I" to "G" terminal must be 10-16 volts DC, with no wire on "S" terminal. Gauge pointer should rest below the "0 PSI" mark. Next, connect the "S" terminal to the "G" terminal (leave "I" and "G" terminals connected). The gauge pointer should rest above the maximum pressure mark.
- Sender resistance can be measured to determine the sender's correct operation. Remove wire to gauge. Connect an ohmmeter to terminal of sender and to engine block.

Approximate pressure sender resistance values are:

Zero pressure = 240 ohms

1/2 gauge reading = 103 ohms

full gauge pressure = 33 ohms.

(You will get half these values on a dual gauge sender.)

- If sender is shorted (0 ohms) gauge will read above full gauge pressure reading.
- If sender has infinite resistance (open) gauge will read below 0 PSI.
- If gauge reads lower than expected, was sealer used on the sender threads? (See illustration.)
- The accuracy of the system (gauge & sender) can be ± 5 PSI at 40 or 50 PSI.
- Use of pipe extenders to plumb both a sender and pressure switch (for horn or warning light) from one port is not recommended. Pressure readings will be accurate, but the weight added to the extended fitting of a vibrating engine may cause fatigue related breakage.
- Teleflex does not offer senders for metric threaded ports.**

9. Dual Station installations:

- When replacing one gauge in a two station installation, the second gauge may need to be replaced as well.
 - Mixing two gauges from different manufacturers to one sender may cause an error in both gauges.
 - If one gauge fails the second gauge will read much higher than expected.
 - If sender fails "open", both gauges will read below the "0" mark.
 - If sender fails "short", both gauges will read above the "full pressure" mark.
10. Twin engines: it may be helpful in troubleshooting to switch either the senders or the gauges from engine to engine.

Oil Pressure Sender I.D. Guide

Use this chart for field identification of Teleflex pressure senders. (ID code stamped on wrench hex of sender. See illustration below chart.)

ID CODE ON SENDER	PART NO.	NPT THREAD SIZE	RANGE (PSI)	RESIST-ANCE RANGE	# OF GAUGES/ SENDERS
02504-00	IA15001	1/8	80	S-W MATCH	1
02504-01	IA15003	1/8	80	S-W MATCH	2
02505-00	IA15016	1/8	100	S-W MATCH	1
02505-01	IA15023	1/8	100	S-W MATCH	2
31	IA15023	1/8	100	S-W MATCH	2
42	IA15016	1/8	100	S-W MATCH	1
80	IA15001	1/8	80	S-W MATCH	1
80+Z	IA15003	1/8	80	S-W MATCH	2
15001	IA15001	1/8	80	S-W MATCH	1
15003	IA15003	1/8	80	S-W MATCH	2
15016	IA15016	1/8	100	S-W MATCH	1
15023	IA15023	1/8	100	S-W MATCH	2

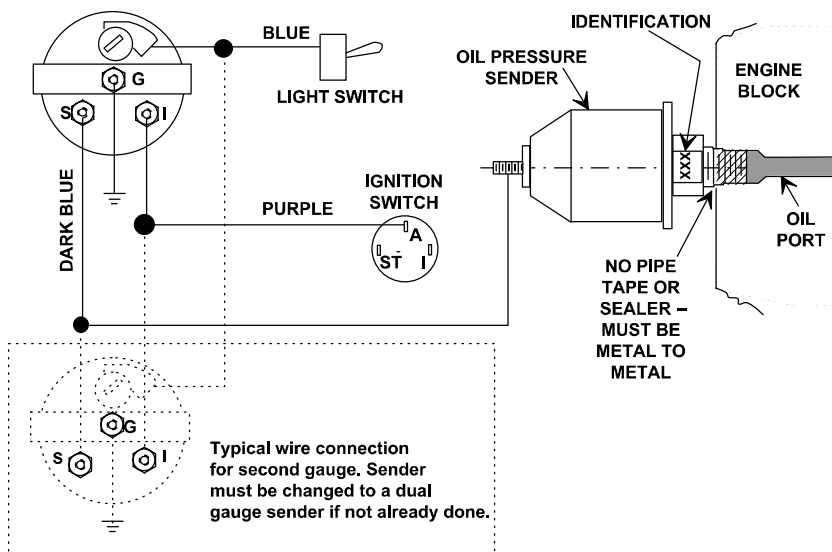

PRESSURE SENDER ID CODE

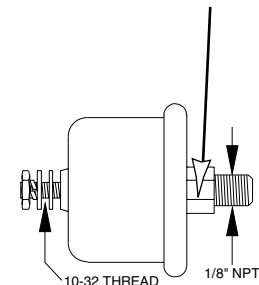

Teleflex Marine Instruments

Speedometer (Electric Paddle Wheel Type)

1. The Competition Speedometer is not included in this trouble shooting guide (call Tech Service 941-907-1000 for assistance).
2. Check all wire connections to see that they are tight and not corroded.
3. Be sure the ring terminals supplied for the three sender wires at the gauge end are crimped to bare wire and making good contact (see Fig. 1).
4. When speedometer is first turned on, the pointer must go to zero. If not, check connections - ground "G" and ignition "I" wires.
5. Voltage at "I" to "G" terminals should be 12-16 VDC.
6. If spinning the sender paddle wheel does not produce speedometer movement, **the system can be checked to see what component is not working by doing one of the following:**
 - a. If you have a tachometer, first remove 3 sender wires from the speedometer, remove tach's gray sender wire and attach to "S" terminal of speedometer. Start engine. If the speedometer pointer gives a reading, the paddlewheel sender was probably not sending a signal to the speedo and is not working.
 - b. If you have a volt/ohmmeter, connect its leads to the "G" and "S" terminals of the speedo.

Turn power to speedometer "ON" and rotate paddlewheel slowly. Voltmeter should show pulsing DC: 12 volts, 0 volts, 12 volts, etc. as paddlewheel rotates. If not, the paddlewheel is probably defective.

- c. Reconnect in the original manner.
7. Be certain the paddle wheel is snapped into the transom bracket. If it is not snapped in correctly, the speedometer will work inaccurately.
 8. If the installation is correct, but the speedometer is still not accurate, the sender may not be installed at the correct angle.

The old style sender is designed for a 12° transom. Installation on transoms that deviate from that angle may require use of 1 or 2 wedges (Figure 2 above) in the sender installation. The wedges can be used either thin end up or down to achieve as close to a 12° transom position as possible.

The new style sender will accommodate transom angles from 13° to 20° . Installations outside that range will also require fabrication and installation of shims to bring the angle into range.
 9. The gauge's part number can be found on its housing.

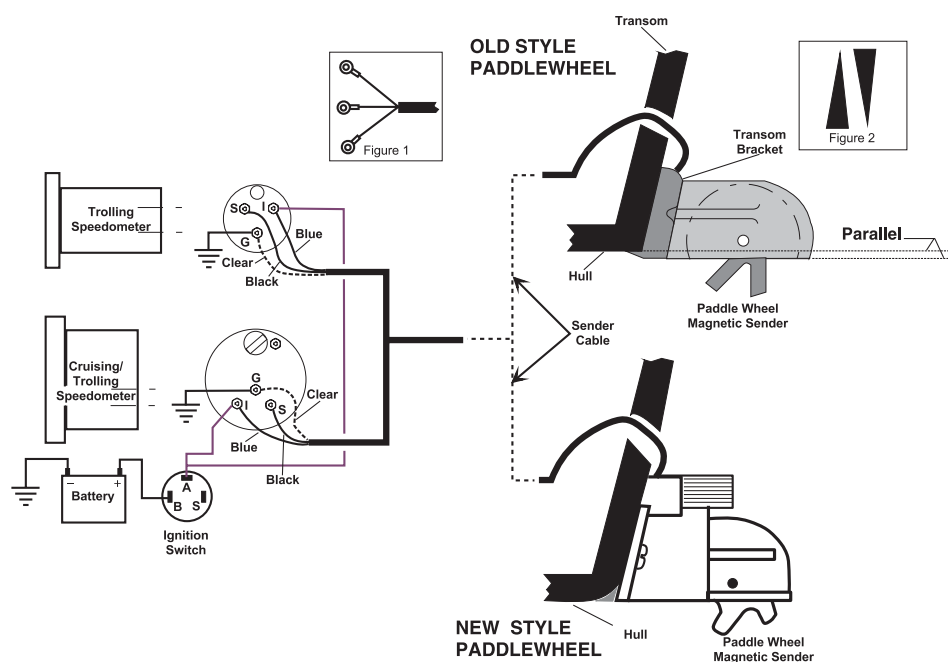

Speedometer (Pitot Tube Type)

1. The pitot tube speedometer operates by air pressure changes in the hose and speedometer. Water is pushed through the pitot into the hose, compressing the air. Air pressure increases with boat speed, causing the gauge to indicate faster speeds. **There must be air in the hose.** When the boat is still and the hose is removed from the back of the speedo, no water should pour from the hose. If water is in the hose, blow it back to the pitot until air bubbles exit. Reconnect the hose to the speedometer.
2. Check hose for kinks or sharp bends that may be cutting off air flow.
3. Sometimes when a speedometer sits in the environment for quite a while, as over the winter, the internal metal parts form a coating (verdigris). This may make it difficult for the speedometer to operate. However, it should recover with repeated use.
4. If adjustable air pressure is available, **standard calibration speedometers should react to the following pressures: 5 PSI = 20 MPH; 11 PSI = 30 MPH; 19 PSI = 40 MPH; and 30 PSI = 50 MPH.**
5. **A standard speedometer using the Mercury/Mariner speed pickup in the engine foot will read approximately 10% faster than with a Teleflex pitot mounted to the transom.** Speedometers with the suffix "M" after the Part Number are calibrated for use with in-foot pickups.

To test as in (4) above: 5.6 PSI = 20 MPH; 12.6 PSI = 30 MPH; 22.4 PSI = 40 MPH; and 35 PSI = 50 MPH.

6. If the hose tends to blow off the hose barb connection at higher speeds (to 80 MPH), clamp a plastic wire tie over the hose on the barb.
7. The pitot should be transom mounted at least 6" from propeller tips.
8. If the speedometer is not working, check that the pitot has not kicked partially or all the way up. This patented kickup feature is designed to prevent transom damage from trailering or submerged objects, and should not be disabled.
9. The pitot is weed resistant, however, debris can accumulate in its opening. Prolonged idleness in the water may attract barnacles or algae. Be sure the pitot allows water to enter the hose.
10. When winterizing the boat, winterize the speedometer system also. Remove the hose from the speedometer head. Blow air into the hose towards the pitot. Blow out any water that may be trapped in the hose. Leave the hose loose and the inside of the speedometer should dry out over the winter (if there is any moisture inside). Reconnect the hose before launching the boat (or the hose will siphon water into the boat).
11. **Accuracy between 5 and 35 MPH requires** the use of either a Teleflex pitot type 5-35 MPH speedometer or a Teleflex electric (paddlewheel) type speedometer.

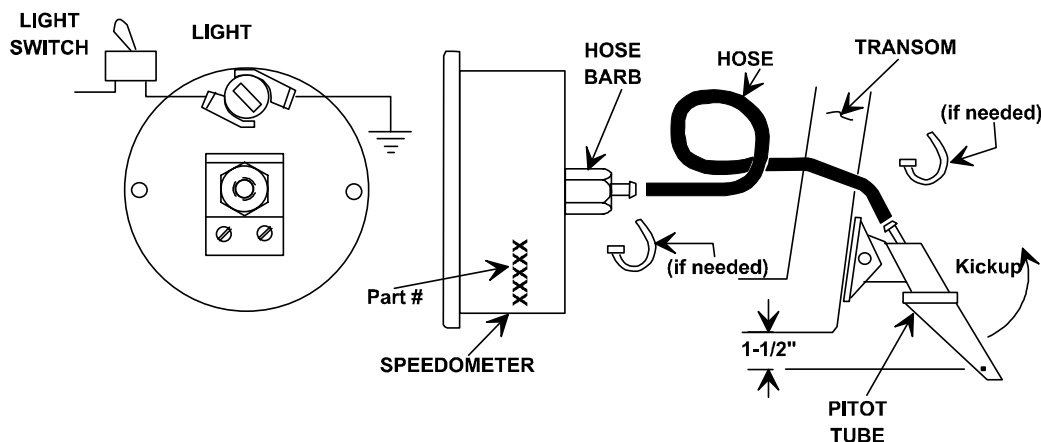

Teleflex Marine Instruments

Tachometers (Diesel)

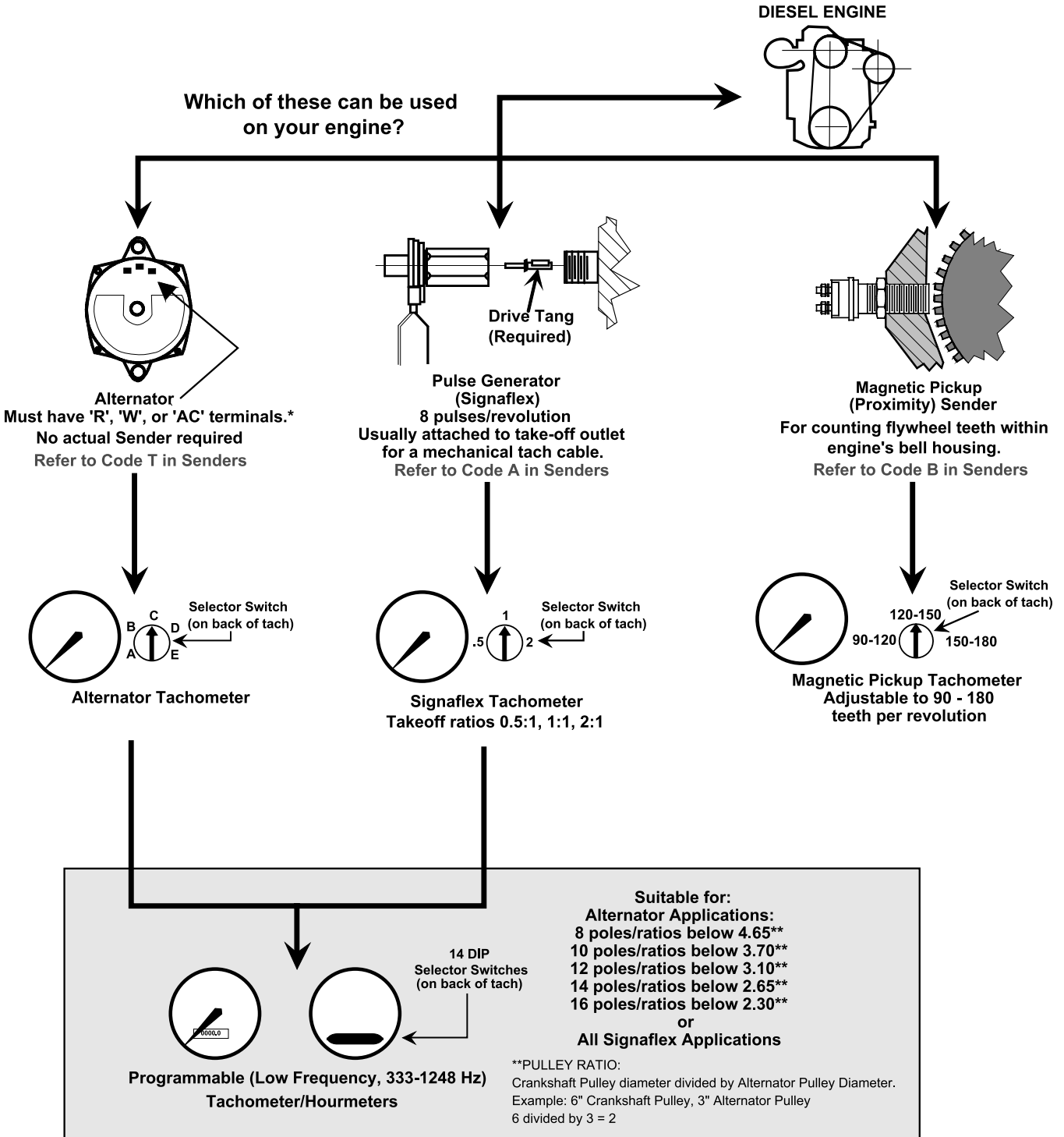

INSTRUMENTS tech reference

Tachometer Guide (Diesels)

Diesel tachs may require a sender, depending on the engine. These tachs are offered in “dedicated” (specific sender type) versions. Diesel Tach/Hourmeters are offered in a “programmable” versions (Heavy Duty) which accommodate several sender types or “dedicated” versions (Lido Pro).

1. Engine has No Provision for Tach Sender:

Use Diesel Alternator Tachometer (CODE “T”). Diesel Alternator tachs read the alternator signal. **Alternator must have an AC tap**, usually marked “AC”, “R” or “W”. If there’s no tap, a local alternator repair shop can usually add one at a small cost. You **need to know the number of magnetic poles** in your alternator. Consult the alternator maker or local alternator repair shop if in doubt. Also, **calculate the pulley ratio from crankshaft to alternator.** Determine **Switch Setting**, based on Number of Alternator Poles and Crankshaft-to-Alternator Pulley Ratio, calculated as follows:

$$\text{Crank Pulley Dia. / Alternator Pulley Dia.} = \text{Pulley Ratio}$$

(Match number of poles and pulley ratio to the appropriate switch position setting on the chart below.)

DIESEL ALTERNATOR TACH SWITCH SETTING CHART						
(RATIO = Crank Pulley Diameter to Alternator Pulley Diameter)						
NUMBER OF ALTERNATOR POLES:	8	10	12	14	16	SWITCH SETTING
TACH WITH 5-POSITION SWITCH:						
RATIO	1.5:1	1.2:1	1:1	0.857:1	0.75:1	A
RATIO	2.25:1	1.8:1	1.5:1	1.28:1	1.125:1	B
RATIO	3:1	2.4:1	2:1	1.71:1	1.5:1	C
RATIO	3.75:1	3:1	2.5:1	2.14:1	1.875:1	D
RATIO	4.5:1	3.6:1	3:1	2.57:1	2.25:1	E
TACH WITH 3-POSITION SWITCH (Early Style):						
RATIO	1.5:1	1.2:1	1:1	0.857:1	0.75:1	A
RATIO	2.5:1	2.0:1	1.67:1	1.4:1	1.25:1	B
RATIO	3.75:1	3.0:1	2.5:1	2.15:1	1.875:1	C

NOTE: Tachometers are factory calibrated for several combinations of poles and pulley ratios, but in almost all cases you will need a Portable Master Shop Tachometer for initial calibration. Detailed calibration and adjustment procedures are documented in instructions included with Teleflex tachometers.

Programmable Tachometer/Hourmeter:

To determine if programmable tachometer is suitable for the application, calculate **Full Scale Frequency (FSF)** as follows:

$$\# \text{ Alternator Poles} \times \text{Pulley Ratio} \times 33.33 = \text{FSF (Hz)}$$

(If F.S.F. is 1248 Hz or less, use Low Frequency model Programmable Tach/Hourmeter; if over 1248 Hz, use Diesel Alternator Tachometer.)

2. Engine has Magnetic Proximity Sender Mount:

Use Diesel Magnetic Pickup Tach with Magnetic Pickup Sender (CODE “B”). The sender mounts in a 3/4-16 threaded hole, usually in the bell housing. As each gear tooth passes the sender, a pulse signal is generated. Works with 90 to 180 teeth on gear. (The frequency is too high to allow use of the “Programmable Tach/Hourmeter”.)

CODE B
MAGNETIC
PROXIMITY
SENDER

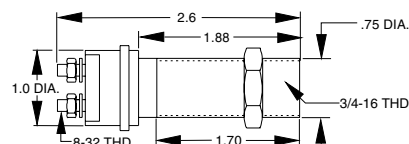

3. Engine has a Takeoff for a Mechanical Tachometer Cable

Use Diesel Signaflex Tach with Signaflex Sender (CODE “A”). The Signaflex sender mounts in place of a tachometer cable. Select the drive tang that fits the engagement hole. (The Programmable Tach/ Hourmeter may be used in this application.)

CODE A
SIGNAFLEX
SENDER

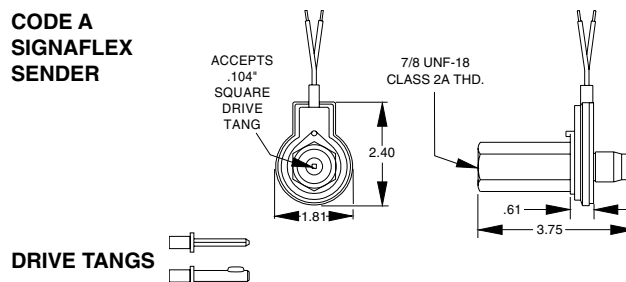

Teleflex Marine Instruments

Tach & Tach/Hourmeter (Diesel Alternator Type)

(For Diesel or Low-RPM Inboard and Stern Drive Engines:)

1. For this type of tachometer, the engine is usually a diesel, but can be a low-RPM gasoline stern drive or inboard.
2. Check all wire connections to see that they're tight and not corroded. **NOTE:** Some older style tachometers operate with only Ground and Sender connections. Teleflex tachs must have 12 VDC (from the ignition switch, "ON" when engine is running) to the "IGN" stud.
3. When tachometer is first turned on, pointer **must** go to zero ± 50 RPM. If not, check connections (if OK, tachometer is probably faulty).
4. **Voltages with engine running should be:**

IGN to GND terminal: 12 VDC minimum;
SEND to GND terminal: 5 VAC minimum.

5. Arrow on rotary selector switch must be pointed directly at setting or the tachometer will go to full scale.
6. Some alternators do not have output terminal for tachometer signal. A local alternator repair shop can install a tap from the internal rectifier to facilitate a tachometer signal from the alternator.
7. If the number of alternator poles is not known, measure actual RPM with a Master Tachometer. Rotate tach selector switch to the letter that puts the tach closest to actual RPM. Final calibration adjustment requires a Remote Master Tachometer. Connect the master tach and start the engine. At about 1,500-2,000 RPM, use a jeweller's screwdriver to carefully adjust the potentiometer in the "CAL" hole (about 10 o'clock on the rear of the tach), bringing the tachometer into agreement with the Master Tach. Only a minimal amount of turning is required. **Overtorquing of adjustment will damage gauge mechanism.** Turning clockwise increases tach reading, counterclockwise reduces reading. If the tach cannot be brought into calibration, the black Range Selector Switch is probably on the wrong setting.
8. Alternator belt slippage will cause some error on the tachometer.
9. Dual stations: the sender will drive two tachometers. Simply connect "IGN" to "IGN", "GND" to "GND", etc. **NOTE:** mixing brands/types (such as 2-wire/3-wire, see paragraph 2 above) may cause problems.

(DIESEL ALTERNATOR TACHOMETER)

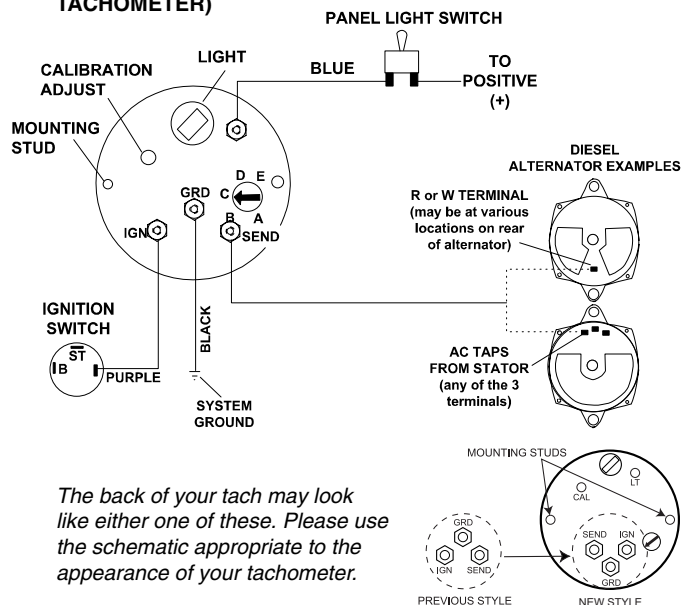

Tachometer (Magnetic Pickup) (Code B)

(For Diesel or Gas Engines with a Sender Mounting Point in Bell Housing or Adjacent to a Rotating Gear:)

1. This tachometer is for a diesel or gasoline engine having a sender mounting point (3/4-16 thread) in the bell housing (or adjacent to some other rotating gear), and 12-16 VDC (24 Volt systems can be accommodated with a Voltage Reducer).
2. Check all wire connections to see that they're tight and not corroded. **NOTE:** Some older style tachometers operate with only Ground and Sender connections. Teleflex tachs must have 12 VDC (from the ignition switch, "ON" when engine is running) to the "IGN" stud.
3. When tachometer is first turned on, pointer **must** go to zero ± 50 RPM. If not, check connections (if OK, tachometer is probably faulty).
4. **Voltages with engine running should be:**
IGN to GND terminal: 12-16 VDC.
SEND to GND terminal: 0.3 VAC minimum at idle; (voltage will increase with engine speed).
5. Set rotary switch on tachometer back to the range that includes the number of gear teeth that pass by the Magnetic Pickup in **one** crankshaft revolution. This information can be obtained from the Engine Distributor or Dealer. Arrow on slot must point to setting; if it is between settings, the tach will go full scale when engine is started.

- Final calibration requires a Remote Master Tachometer. Connect Master Tach and start engine. At about 1,500-2,000 RPM, use a jeweller's screwdriver to carefully adjust the potentiometer in the "CAL" hole (about 10 o'clock on the rear of the tach), bringing the tachometer into agreement with the Master Tach. Only a minimal turning is required. **Overtorquing of adjustment will damage gauge mechanism.** Turning clockwise increases tach reading, counterclockwise reduces reading. If the tachometer cannot be brought into calibration, the black Range Selector Switch is probably on the wrong setting.
- The end of the sender must be within 1/32" - 1/16" of the gear teeth, **but not touching the teeth.** To adjust, **stop engine**, loosen the lock nut, and gently turn the sender clockwise until it touches the flywheel. Back off (counterclockwise) one turn, and secure with the locknut.
- Rust buildup between the teeth can cause signal loss from the sender.
- Dual stations: the sender will drive two tachometers. Simply connect "IGN" to "IGN", "GND" to "GND", etc. **NOTE:** mixing brands/types (such as 2-wire/3-wire, see paragraph 2 above) may cause problems.

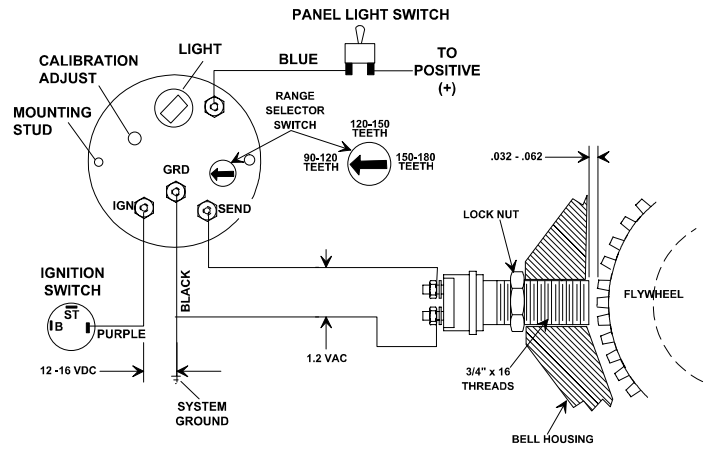

The back of your tach may look like either one of these. Please use the schematic appropriate to the appearance of your tachometer.

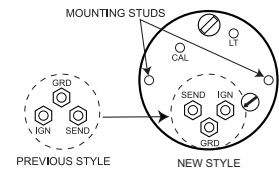

Tachometer (Signaflex) (Code A)

(For Engines which have a Mounting Point for a Mechanical Tach Cable.)

- This tachometer is for a diesel or gasoline engine with a tachometer drive cable mounting point, and 12-16 VDC (24 Volt systems can be accommodated with a Voltage Reducer).
- Check wire connections. **NOTE:** Some older style tachs operate with only Ground and Sender connections. Teleflex tachs must have 12 VDC (from ignition switch, "ON" when engine is running) to "IGN" stud.
- When tachometer is first turned on, pointer **must** go to zero ± 50 RPM. If not, check connections (if OK, tachometer is probably faulty).
- Voltages with engine running should be:**
IGN to GND terminal: 12-16 VDC.
SEND to GND terminal: 0.3 VAC minimum at idle; (voltage will increase with engine speed).
- Rotary switch on tachometer back must be set to corresponding engine takeoff ratio (takeoff revolutions vs. crankshaft revolutions). This information can be obtained from the Engine Distributor or Dealer. Arrow on slot must point to setting; if between settings, tach will go full scale when engine is running.
- Sender is made for engines with a round drive tang fitting and keyway (some engines have a .104" square tang fitting). It will not fit slotted keyway drives. Mounting point threads must be 7/8-18.
- The sender produces 8 pulses per revolution.

- Drive tang must be properly inserted in both sender and takeoff, and rotating internally. Tang must not be broken, worn, or rounded. At about 1,000 RPM, sender should put out 6 volts peak-to-peak (AC sine wave) with tach disconnected.
- Dual stations: the sender will drive two tachometers. Simply connect "IGN" to "IGN", "GND" to "GND", etc. Note: mixing brands/types (such as 2-wire/3-wire, see paragraph 2 above) may cause problems.

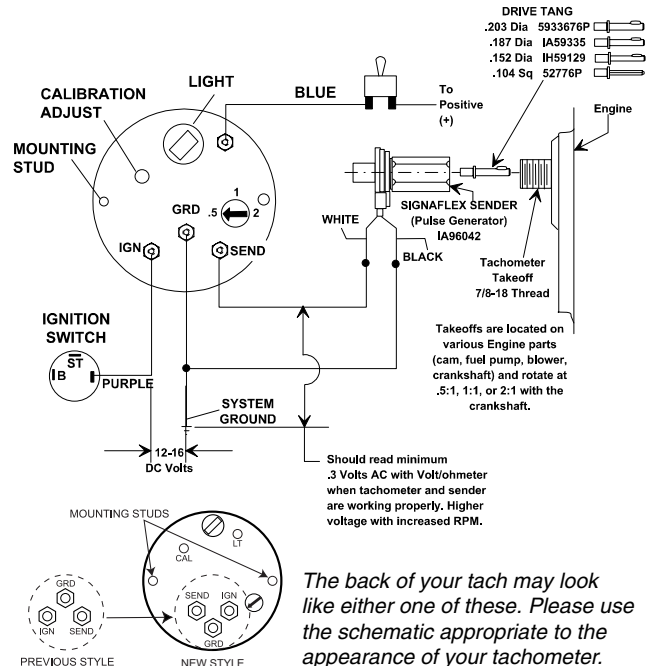

Teleflex Marine Instruments

Tachometer Guide (Gas Inboard, Stern Drive)

Teleflex 6K, 7K or 8K RPM Tachometers and Tachometer/Hourmeters are suitable for use with gas engines with factory-installed ignition systems, except: 1960's vintage Mercruisers with Thunderbolt I ignition, and Indmar LT-1 engines.

Rotary selector switch on rear of tachometer must be set to number of cylinders in the engine: 4 cylinder = 4C, 6 cylinder = 6C, 8 cylinder = 8C

Note: Teleflex has not tested the various aftermarket bolt-on ignition systems and makes no statement as to their compatibility with our tachometers. If you have such a system, contact the ignition system manufacturer and ask if they have determined compatibility.

Tachometer Guide (Outboard)

All Teleflex 6K, 7K, or 8K rpm Tachometers and Tachometer/Hourmeters are suitable for use with Outboard engines with alternators, except: Older Chrysler/Force Engines with 20-pole Prestolite alternators, which require a special tachometer, P/N 53743P, International High-profile style. These engine models include:

- Chrysler Outboards: 55, 60 HP (1968-1983)
- Force Outboards: (US Marine) 85, 125 HP (thru 1989); 90-120 HP prior to 1991 Revision 'H'; 150 HP prior to 1991 Revision 'B'
- Force/US Marine L-Drives: 85 & 125 HP (1989); 90-120 HP (prior to 1991 Revision 'B')

Tachometers (Inboard & Stern Drive 4-Stroke Engines – Standard Ignition)

1. Tachometer will not operate on a MerCruiser with Thunderbolt I (early 1970's era, but will operate on subsequent models) or an IndMar LT-1 electronic ignition. Tachometer will operate with other OEM electronic engine ignition systems. Teleflex has not tested aftermarket systems and cannot guarantee their compatibility.
2. Check all wire connections to see that they're tight and not corroded. **NOTE:** Some older style tachometers operate with only Ground and Sender connections. Teleflex tachs must have 12 VDC (from the ignition switch, "ON" when engine is running) to the "IGN" stud.
3. When tachometer is first turned on, pointer **must** go to zero ± 50 RPM. If not, check connections (if OK, tachometer is probably faulty).
4. Arrow on rotary selector switch must point directly at setting or the tachometer pointer may go to full scale when engine is started.
5. Tachometer switch arrow should be pointed at 4C, 6C or 8C to correspond to the number of engine cylinders. Disregard other settings.
6. The tachometer part number is stamped on the housing.
7. Tachometer does have a "CAL." potentiometer feature to fine tune the tachometer a few hundred RPM or to sync two tachometers.

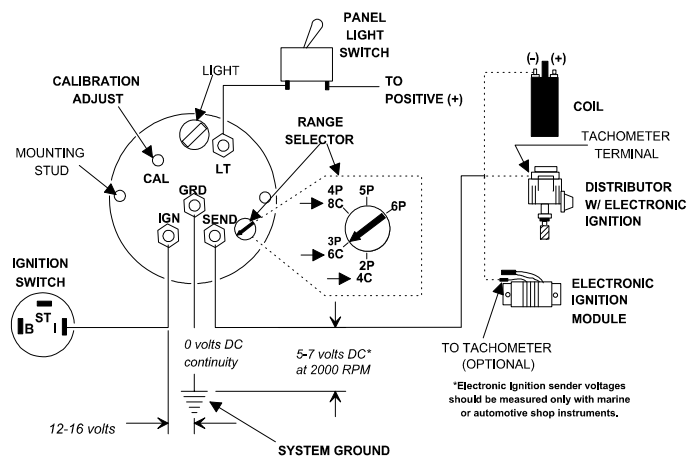

The back of your tach may look like either one of these. Please use the schematic appropriate to the appearance of your tachometer.

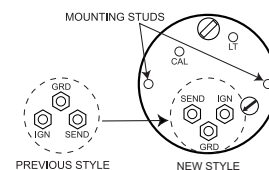

8. Tachometer will also operate on outboard engines with an alternator having 4 through 12 magnetic poles.
9. Dual stations: the sender will drive two tachometers. Connect "IGN" to "IGN", "GND" to "GND", etc. **NOTE:** mixing brands/types (such as 2-wire/3-wire, see paragraph 2 above) may cause problems.

Other Outboard Engine Applications

Rotary selector switch on rear of tachometer must be set to number of pulses from alternator per engine revolution. See Chart below (if your specific year/horsepower is not listed, see "All others" under your brand).

NUMBER	SWITCH	
MAKE/MODEL	ALTERNATOR POLES	POSITION
CHRYSLER**:		
35, 70 HP and up (1968-1983)	12	6P
55 & 65 HP 20	Use 57743P	
EVINRUDE**/JOHNSON**/OMC SEADRIVE:		
Less than 70 HP (2 cylinder, 2 stroke)	10	5P
All SeaDrives and All Other Models	12	6P
Engines with warning light tachometers require similar replacements		
FORCE (U.S. MARINE):		
50 HP (through early 1987 A,B models)	8	4P
90, 120 HP (all to 1999 Rev. H), 150 HP (all to 1991 Revision 'B') L-Drive, 85, 125 HP (1989) L-Drive, 90, 120 HP (all to 1999 Rev. B)	20	Use 57743P
All Other Models	12	6P
HONDA:		
35, 40****, 45, 50**** HP with alternator	6	3P
All Other Models with Alternator	4	2P
BF 8D, BF 9.9D, BF 15D, BF 20D	12	6P
MERCURY***/MARINER***:		
2-stroke 6 thru 25 HP (U.S. Origin)	8	4P
30, 40 HP, (2 cylinder) USA Serial 0G53314 and up	12	6P
35, 40 HP, (2 cylinder) USA serial #582399 & up		
Belgium serial #9298955 and up	8	4P
Canada serial #7169337 and up		
Australian serial #8070639 and up		
All Other 2-stroke with Alternator		
4-stroke 8, 9.9 HP	6	3P
All Other 4-stroke Models	12	6P
SUZUKI:		
2-stroke Less than 55 HP -(Except noted below)		
60, 65 HP thru 1985		
Cabrea 50-60 HP	4	2P
25, 30 HP 1993 and newer	6	3P
55, 60 HP 1985 and newer		
75 HP and up 1985 and newer		
Cabrea 75 HP and up	12	6P
4-stroke All 4-stroke Models		
TOHATSU/NISSAN:		
2-stroke All 2 cylinder models with alternator	4	2P
All 3 cylinder models with alternator	6	3P
All 4 cylinder models, except Tiller model	12	6P
Tiller steered 40 HP	4	2P
4-stroke All require Tohatsu tachometer with warning lights	12	6P
YAMAHA:		
2-stroke 9.9, 15 HP	4	2P
25 thru 70 HP	6	3P
90 thru 250 HP	12	6P
4-stroke F/T 9.9, F15 HP	6	3P
F/T25 thru F/T225 HP	12	6P

* Tachs will not work on engines with Magnapower I ignition. **88-115 HP "Special" models may require addition of an OMC Voltage Regulator to the engine, or a 2,000-ohm (or larger) resistor to the rear of the tach. ***Mariner 30 & 40 HP (2 cylinder) engines require a Module (Mercury P/N 17461A2) when using any of these tachs. **** Honda 40 & 50 HP models may require module (Honda P/N 06383-ZV5305 if tachometer is erratic between idle and 1800 rpm. **Note:** Engine designs are subject to change. Data above is based on the latest information available at the time of publication. Teleflex assumes no responsibility for its correctness or the misapplication of its products. Teleflex tachometers designated as "O/B & 4-Stroke Gas Engines" are compatible with all engine-manufacturer-designed electronic systems except Indmar LT-1 and (early 1970's era) MerCruiser Thunderbolt I, and have not been tested for suitability with aftermarket add-on electronic ignition systems. For help, contact Teleflex Electrical Technical Service at (941) 907-1000, Extension 8222.

Teleflex Marine Instruments

Tachometer (Outboard Engines — 4 Through 12 Pole Alternators)

1. Outboard engine must have alternator (stator) with 4 to 12 magnetic poles. This is how the tachometer gets its signal. The tachometer will not operate on engines with magneto or lighting coil ignition systems.
2. Check all wire connections to see that they're tight and not corroded. **NOTE:** Some older style tachometers operate with only Ground and Sender connections. Teleflex tachs must have 12 VDC (from the ignition switch, "ON" when engine is running) to the "IGN" stud.
3. When tachometer is first turned on, pointer **must** go to zero ± 50 RPM. If not, check connections (if OK, tachometer is probably faulty).
4. **Voltages with engine running should be:**
IGN to GND Terminal: 12 VDC minimum.
SEND to GND: 5 VAC minimum at idle.
 If you don't get the sender-to-ground voltages shown, voltage rectifier (converts AC to DC voltage) may be weakening. Have it checked.
5. Sender wire must be connected (possibly through control) to either of two wires from alternator going to the rectifier (usually yellow or yellow/gray on U.S.-built engines).
6. Arrow on rotary selector switch must be pointed directly at a setting or the tachometer pointer will go to full scale when engine is started.
7. Evinrude/Johnson "Specials" (48, 88, 112 HP, etc.): If the pointer falls back to "Zero" when operating at about 4,000 rpm or higher, you may have to add a 2,000 ohm, 1/2 watt (or larger) resistor, connected from the "SEND" to "GND" terminal.
8. Tachometer will not operate on older Force engines with 20-pole alternator. Consult engine dealer for number of poles in your engine.
9. Dual stations: the sender will drive two tachometers. Simply connect "IGN" to "IGN", "GND" to "GND", etc. **NOTE:** mixing brands/types (such as 2-wire/3-wire, see paragraph 2 above) may cause problems.

CAUTION: DISCONNECT BATTERY BEFORE MAKING CONNECTIONS.

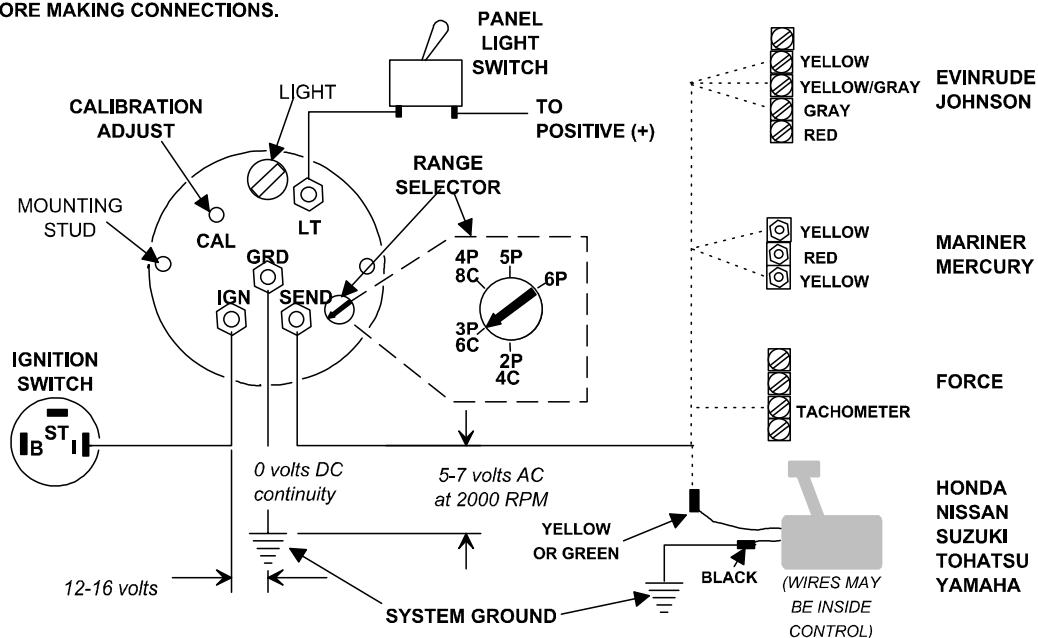

The back of your tach may look like either one of these. Please use the schematic appropriate to the appearance of your tachometer.

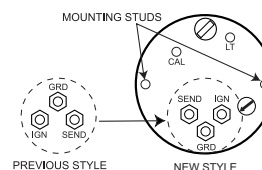

Tachometer — Outboard Engines (Typical Outboard Rectifier Wiring)

Wire colors vary with engine manufacturers. The colors depicted are typical of Johnson/Evinrude and Mercury outboard engines. However, most engines use some form of yellow for the two wires from the stator to the rectifier.

For the outboard tachometer to be getting a proper signal on the “SEND” wire, **the following AC voltages must be present at the yellow or yellow/gray wire from Stator to Ground:**

Minimum 3.5 VAC
(typically 6 volts or higher).

The tachometer “SEND” wire can be connected to either the yellow or yellow/gray wire from stator.

NOTE: Wire Color Can Vary — on some Johnson/Evinrude engines there may be a yellow/blue wire from the rectifier. This wire may sometimes be used for the tachometer sender connection with favorable results. In many domestic engine installations, the stator wires result in a gray wire routed to or near the throttle control where it can be used for the tachometer signal. Other engines have other color wires routed to or near the control:

Yamaha — green,
Nissan/Tohatsu/Suzuki — yellow,
Honda — gray.

Always refer to the tachometer instruction sheet for wiring information.

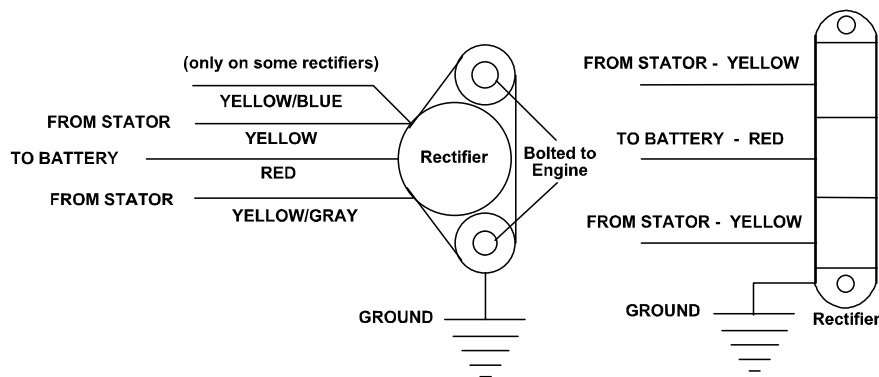

Fogging of Instruments

Until the introduction of Teleflex fog resistant gauges, all commercially available gauges were subject to fogging. Teleflex Pro Series gauges include a coating on the inside of the lens that prevents condensation from forming. Depending on the outside temperature, humidity, air flow to the gauge, and gauge placement in a panel, other gauges can fog. Usually the gauge fogs when the inside and outside temperatures of a gauge change drastically. Such a change occurs when the gauge is first turned on. The meter movement of the gauge heats the moist air inside while air outside the glass remains cooler, and the gauge fogs.

If the gauge is mounted vertically in a panel, the fog rises to the top of the gauge with little fog on the glass. If the gauge were horizontal, the fog would rise to the glass, probably covering it entirely. If the gauge were tilted back 45 degrees, only about half the glass would be fogged.

Fogging is dissipated when the heat inside the gauge causes an air convection to begin moving from the back of the gauge through its interior.

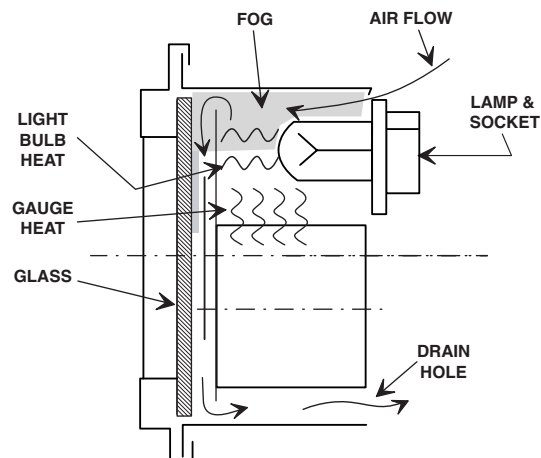

GAUGE SHOWN VERTICAL

This constant flow of air should slowly clear the glass. Turning on the gauge light (causing more heat) helps in clearing the glass. If the glass does not clear, remove the socket and bulb and let a lot of air into the gauge. This step may be necessary in high humidity conditions. If air flow behind the gauge is poor (area sealed off), it may be more difficult to dissipate the fog. Replacing the fogging gauge is a last resort. It is not always an effective remedy, unless the replacement is a Pro Series unit.

Teleflex Marine Instruments

Engine Trim Systems:

*Evinrude/Force/Johnson/
Mariner/Mercury/OMC/
Suzuki 4-Stroke/Yamaha*

1. Senders for trim systems are not available from Teleflex. Senders must be purchased from the engine dealer.
2. Teleflex does not furnish trim gauges for the following outboard engines: Nissan, Tohatsu, Chrysler & pre '95 Force.
3. Make sure your engine has a trim sender. Not all engines have a trim gauge option. The sender usually has two wires - brown with white stripe (Yamaha is pink. Suzuki 4-stroke 2002 is white with yellow tracers) to gauge sender terminal, and black to ground. If the gauge seems to operate backwards from the way it should go, the wrong (not compatible) gauge is being used with the sender.
4. The Trim Gauge can be tested by: Power the gauge by connecting a positive wire to the "I" terminal and a ground wire to the "G" terminal. Have no other wires connected to the gauge. Pointer will read full UP (all but the Johnson/Evinrude and Suzuki 4-Stroke 2002 outboards - they will read full DOWN). Next, with the power still connected, short the sender terminal at the gauge to ground. Pointer should go to the full DOWN position (all but the Johnson/Evinrude and Suzuki 4-Stroke 2002 outboards - they will go to full UP).
5. Teleflex has special gauges (low current draw) for Yamaha EST series stern drive engines. Other Teleflex trim gauges will damage the pre-2001 Yamaha trim sender.

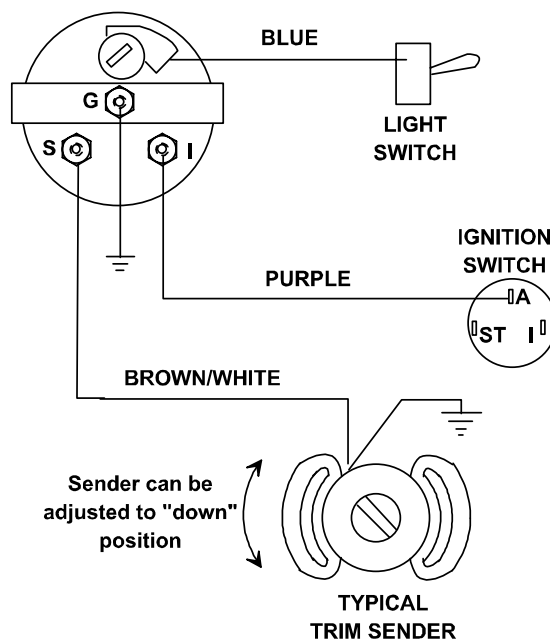

Typical Trim Sender Resistance Ranges

Engine Type	Sender Resistance (Ohms)	
	Up	Down
Evinrude/Johnson	10	88
Mariner/Mercury O/B's, Mercruiser,	167	10
OMC Cobra, & Volvo DP/SX I/O's.	167	10
Force '95 & on 40, 50, 90 & 120 single ram.	167	10
Mercruiser Alpha w/sender for 2 gauges	84	5
Mercruiser Bravo w/sender for 2 gauges	84	5
Suzuki 4-stroke 2002 & on	2.5	88
Yamaha EST Series I/O's (low current draw)	167	10
Yamaha Outboards, pre 2001	411	110
Yamaha Outboards, 2001 & on	167	10

U.S./Metric Conversion Chart:

UNIT	X	= UNIT
U.S. TO METRIC:		
Feet	.3048	Meters
Meters	3.2808	Feet
METRIC TO U.S.:		
Inches	25.4	Millimeters
Millimeters	.0394	Feet

All Tech Support and Instruction Documents can be downloaded as Acrobat® PDF files from our web site: www.teleflexmarine.com

Engine Trim Systems: Honda Outboards

Normal gauge/sender operation: Pointer reflects engine movement within the trim and tilt ranges. At the end of "Trim" range (point where trim speed increases), the pointer will be at the third graduation, balance of travel to full "Up" position will occur during "Tilt" range.

1. Senders for trim systems are not available from Teleflex. Senders must be purchased from the engine dealer.
2. Make sure your engine has a trim sender. Not all engines have a trim gauge option.
3. The Honda sender harness has three wires - yellow/blue stripe to gauge sender (S) terminal, black to ground (G) terminal, black/yellow to ignition (I) terminal.
4. The Trim Gauge can be tested by: Power the gauge by connecting a 12 vdc positive wire to the "I" terminal and a ground wire to the "G" terminal. Have no other wires connected to the gauge. The pointer will slowly move towards the "Up" end of the scale. This will take several seconds, and the pointer should stop to the right of the last "Up" mark. Next, with the power

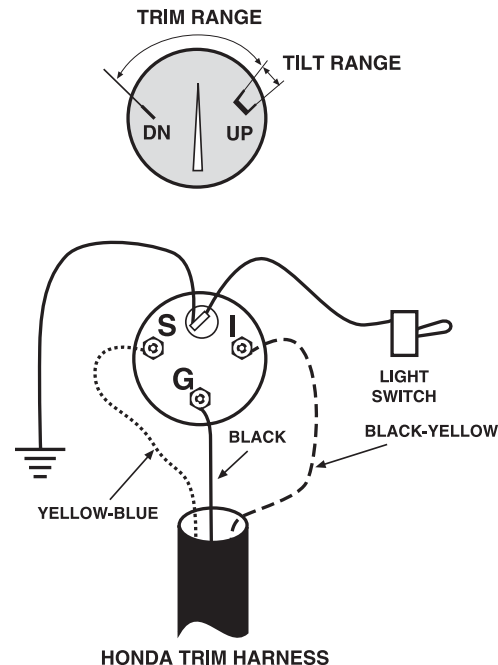

still connected, short the sender "S" terminal at the gauge to ground. Pointer should go to the full "DOWN" position. If the gauge reacts this way, any remaining problems will be in the sender or connecting wiring.

Engine Trim Systems: Suzuki 2-Stroke Outboards

Normal gauge/sender operation: Pointer reflects engine movement within the trim range. At the point where trim speed increases, the pointer will be at the full "Up" position.

1. Senders for trim systems are not available from Teleflex. Senders must be purchased from the engine dealer.
2. Make sure your engine has a trim sender. Not all engines have a trim gauge option.
3. The Suzuki sender harness has a 4-wire connector that mates with the short harness from the gauge. Make sure the connectors are properly connected. In addition, the gauge requires a ground connection (black wire with gray stripe), and 12 vdc (gray wire) that switches on/off with the key switch. If lighting is desired, connect the light socket's black wire to ground, and its white wire to another gauge's light terminal or the panel light switch.
4. The Trim Gauge can be tested by: Disconnect the 4-wire harness connection. Power the gauge by connecting 12 vdc positive to the gray

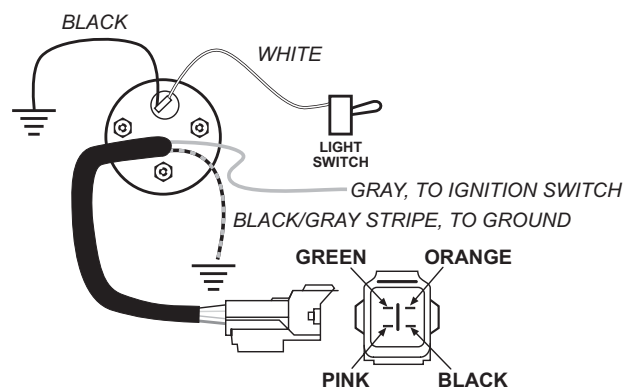

wire and a good ground to the black wire with gray stripe. Have no other wires connected to the gauge. The pointer will slowly move towards the "Up" end of the scale. This will take several seconds, and the pointer should stop to the right of the "Up" mark. Next, with the power still connected, **carefully** short the gauge harness's green wire terminal to the pink wire terminal. Pointer should go to the full "DOWN" position. If the gauge reacts this way, any remaining problems will be in the sender or connecting wiring.

Teleflex Marine Instruments

Voltmeter

1. A voltmeter operates in nominal 12 volt systems.
2. It is not to be connected where an ammeter was wired.
3. A voltmeter will alert you to the operation of your electrical system.
4. A voltmeter will not indicate battery condition.
5. When wiring voltmeter, **no connection is made to the "S" terminal.**
6. Gauge part number is stamped on the housing.
7. Accuracy is $\pm 3^\circ$ at 14 VDC (about 1/3 volt on 8-18 volt gauge or 1/4 volt on 10-16 volt gauge).
8. **To test gauges, check resistance between the "I" and "G" terminals, which should be approximately:**
 150 ohms (18 volt gauge)
 130 ohms (16 volt gauge)
9. The schematic shows connections required for dual voltmeters. If one gauge fails, it will not affect the reading of the other voltmeter.
10. When turning the voltmeter on for the first time, note pointer movement. If pointer does not leave the pointer stop pin, the gauge is probably connected backwards. If so, reverse "I" and "G" connections.

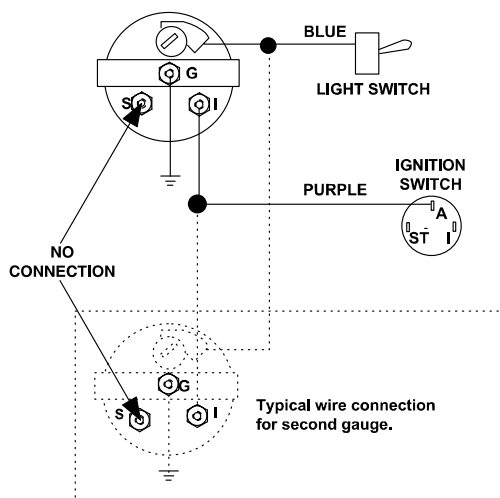
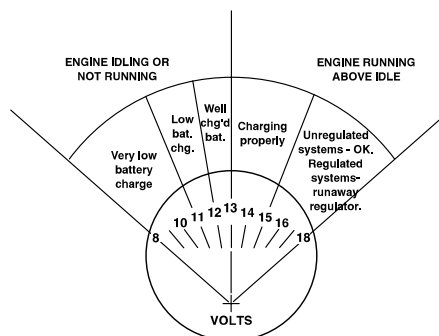

Water Pressure System — Outboard Engines

1. If the instructions shipped with the water pressure gauge kit do not cover your engine, consult engine manual.
2. The light socket can be wired with 14-18 AWG gauge wire.
3. Gauge must be filled with **air** (not water) to operate correctly. Engine water pressure will compress the air in the hose, allowing the gauge to function properly.
4. When winterizing the boat, winterize the water pressure gauge also. Remove water from gauge/hose when storing boat in freezing climates. Trapped water expands when freezing and could damage the gauge.
5. Sometimes when the gauge is idle for a long time, such as winter, the internal metal parts

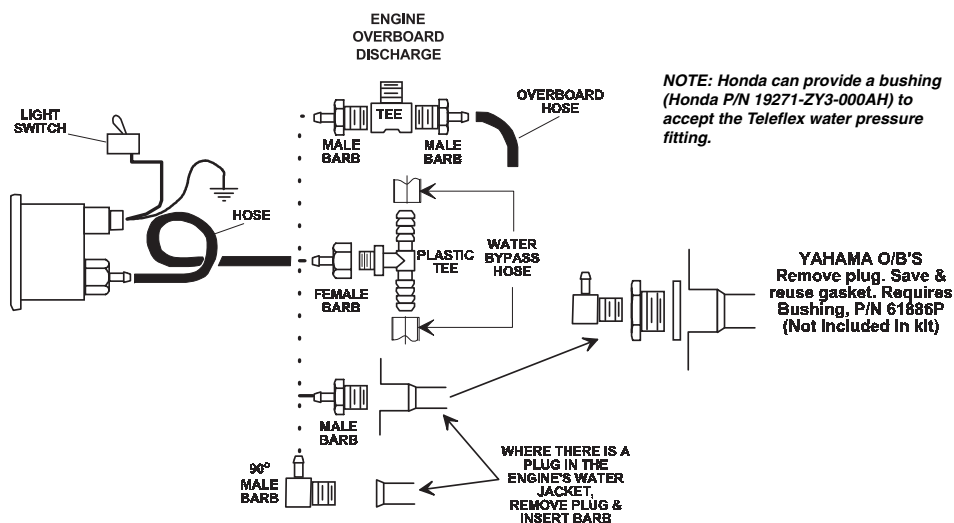

form a coating (verdigris). This makes it difficult for the gauge to operate. However, it should recover with repeated use.

6. See reference guides on this page (or engine maker's information) for the approximate pressures your engine should be obtaining.

O/B Water Pressure Gauge Guide

ENGINE MAKE/MODEL	GAUGE RANGE
EVINRUDE/JOHNSON:	
9.9 to 65 HP (except 1989 40/48/50 HP)	15 PSI (or 30 PSI)
40, 48, 50 HP (1989)	30 PSI
70 HP and larger In-Lines	30 PSI
All V-Loopers thru 1992	15 PSI (or 30 PSI)
Cross-Flow V's	30 PSI
NOTE: 1991-92 Fastrack 150 will require nipple/gasket kit OMC P/N 326467.	
60° Loop-Charged V-6'S, 150-175 HP (93-up)	60 PSI
90° Loop-Charged V-8'S, 200-225 HP (93-up)	60 PSI
90° Loop-Charged V-8 250 HP, 30" Shaft (93-up)	60 PSI
FORCE:	
All with 1/8 NPT port in water jacket	30 PSI
HONDA:	
ALL	30 PSI
MERCURY/MARINER:	
Mercury/Mariner 25/40/45/50 HP 4-stroke	30 PSI
Merc 50/60/65/70HP 3 cyl./2 carb. w/thermostat	30 PSI
Mercury/Mariner 75/90/115 HP 4-stroke	30 PSI
Mercury/Mariner 2.0/2.4/2.5 Liter V-6	30 PSI
Merc/Mariner 135/150/200/225 HP Optimax/DFI	30 PSI
Mercury/Mariner 225 HP 4-stroke	30 PSI
Mercury/Mariner 250/275/300 HP, 3.0/3.4L V-6	30 PSI
ALL OTHERS	15 PSI
NOTE: Following models also require pipe thread adapter – use Merc P/N 22-86306:	
Mariner 40/48/55/60 HP 2-cylinder and	
Merc/Mariner 250/275/300 HP & 3.4L V-6.	
SUZUKI:	
ALL	N/A
TOHATSU/NISSAN:	
90 HP & up w/built-in water pressure sender, or 1/4" I.D. water bypass hose	15 PSI (or 30 PSI)
YAMAHA:	
ALL*	30 PSI
* Requires Metric Adapter, P/N 61886P	

Outboard Water Pressure Ranges

ENGINE MAKE/MODEL	RPM	PSI
Evinrude/Johnson 35 & 40 HP (w/thermostat)	5,200	6-14
Evinrude/Johnson 50 HP (3 cyl.)	5,000	6-12
Evinrude/Johnson 65 & 70 HP (3 cyl. w/thermostat)	5,000	6-12
Evinrude/Johnson V-6 135-220 HP (1987-up)	5,000	6-12
Evinrude/Johnson V-6 135-225 HP (1987-92)	5,000	15-25
Evinrude/Johnson V-6 135-225 HP (1986 & prior, S/N A969903 & below)	5,000	15-25
Mercury/Mariner 25-60 HP (4-stroke)	5,000+	12-25
Mercury/Mariner 30/40 HP (2 cyl.)	5,000+	5-7
Mercury 35/40 HP (2 cyl.)	5,000+	6-14
Mariner 30/40 HP (2 cyl.)	5,000+	8.5-15
Mercury/Mariner 40/45/50 HP (4 cyl.)	5,000+	7.5-14
Merc/Mariner 40/50 (3 cyl. 3 carb. 59 cu.in.)	5,000+	5-7
Merc/Mar 50/55/60 (3 cyl. 3 carb. 52 cu.in.)	5,000+	7-12
Merc/Mar 50/60/70 HP (3 cyl., no thermo.)	5,000+	7.5-14
Merc 50/60/65/70 (3 cyl. 2 carb., thermo.)	5,000+	6-12
Merc/Mariner 55/60 (3 cyl. 3 carb. 59 cu.in.)	5,000+	7-12
Mercury/Mariner 60 HP Bigfoot	5,000+	10-15
Merc 65/70 HP (3 cyl., thermostat)	5,000+	6-12
Merc 65 HP (3 cyl., without thermostat)	5,000+	7.5-14
Mercury 70/75/80/90 HP (3 cyl.)	5,000+	10-15
Mercury/Mariner 75/80/85 HP (4 cyl.)	5,000+	7.5-13
Mariner 75/90 HP (3 cyl.)	5,000+	10-15
Mercury/Mariner 75/90/115 (4-stroke)	5,000+	20.5
Mercury/Mariner 90/115/140 HP (6 cyl.)	5,000+	7.5-13
Mercury/Mariner 100/115 HP (4 cyl.)	5,000+	10-15
Merc/Mar 2.0/2.4/2.5L V6 (S/N to A969903)	5,000+	15-25
Merc/Mar 2.0/2.4/2.5L V6 (S/N A969904-up)	5,000+	12-25
Mercury/Mariner 135/150 Optimax DFI	5,000+	12-25
Mercury 150 HP (6 cyl. in-line)	5,000+	7.5-13
Merc/Mar 200/225 Optimax/DFI (to 1998)	5,000+	6-9
Merc/Mariner 200/225 Optimax/DFI (1999)	5,000+	8-10min.
Merc/Mar 200/225 Optimax/DFI (2000-up)	5,000+	15-25
Merc/Mariner 225/250 3.0L V-6 (to 1998)	5,000+	6-9
Merc/Mariner 225/250 3.0L V-6 (1999)	5,000+	8-10min.
Merc/Mariner 225/250 3.0L V-6 (2000-up)	5,000+	15-25
Merc/Mariner 250/275/300 3.4L V-6	5,000+	10-20
Mercury/Mariner 225 HP (4-stroke)	5,000+	12-25

Water Temperature System Accuracy?

Temperature systems used on boats and other vehicles give a general indication of the temperature in which the sender is operating. We use the term "general" as the system can vary to a maximum $\pm 15^{\circ}\text{F}$ from actual temperature.

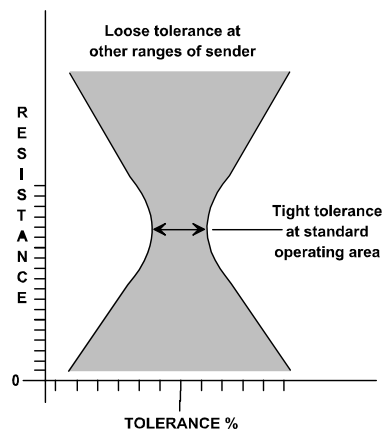
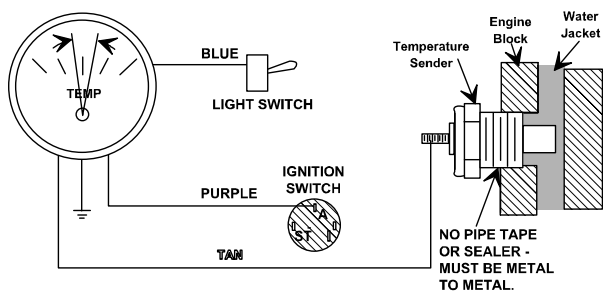

NOTE: Engine designs are subject to change. All data shown is based on the latest information available at the time of publication. Teleflex assumes no responsibility for the accuracy of the information contained herein.

The gauge itself is accurate to within about $\pm 5^{\circ}\text{F}$ at the mid-scale position. The sender is accurate to within $\pm 10^{\circ}\text{F}$ at 200°F (as are competitive units). The sender tolerances widen as temperatures become higher or lower than 200°F . (cont'd. on next page)

Teleflex Marine Instruments

Although sender/gauge tolerances rarely run to the maximums (at the same time), the system can possibly indicate up to 15°F difference from actual temperature at 200°F. These specifications are developed at a system voltage of 14 volts. The sender is also susceptible to “self heating” when electrical current passes through the sender. The self heating causes the sender to become warmer than the actual temperature of the fluid (the gauge is compensated for this effect at 14 volts). If the system voltage is varied to 13 or 15 volts the gauge may read 5 to 6°F higher also.

In a few cases it is necessary to put a temperature sender and a temperature switch (to operate a light or buzzer) in the only engine opening. In this case a “tee” is used. However, when the sender (or switch) is moved away from the water flow, the water around the sender bulb tends to run cooler. The gauge will also show a cooler reading than the actual water temperature inside the engine. Use of “extenders” or “tees” is generally not recommended.

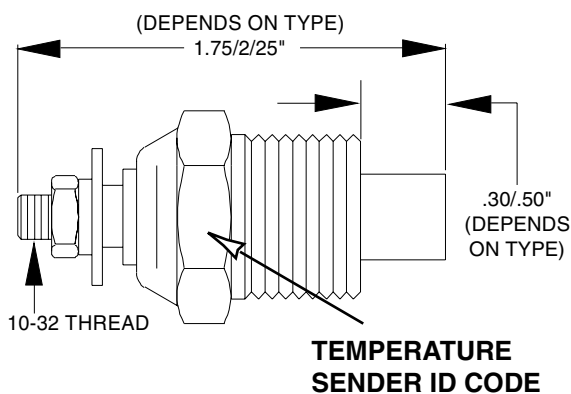

Water Temperature System (Inboards & Stern Drives)

1. To test gauge, voltage from “I” to “G” terminals must be 10-16 VDC. No wire on “S” terminal. Gauge pointer should rest below 120°. Next, connect the “S” terminal to the “G” terminal (leave “I” and “G” terminals connected). The gauge pointer should rest above 240°.
2. The resistance of the sender can be measured to determine the sender’s correct operation. Remove wire to gauge. Connect an ohmmeter to terminal of sender and to engine block. Approximate values are: 75°F (room temperature) = 600 to 800 ohms; 212°F = 55

Water & Oil Temperature Sender Identification Guide

Use this chart for field identification of Teleflex water temperature senders. (ID code stamped on wrench hex of sender. See illustration at left of chart.)

ID CODE ON SENDER	PART NO.	NPT THREAD SIZE	RANGE (°F)	RESISTANCE RANGE	# OF GAUGES/ SENDERS
WATER TEMPERATURE:					
003	52320S003	1/2	120-240°F	S-W MATCH	1
004	52320S004	1/4	120-240°F	S-W MATCH	1
009	52320S009	3/8	120-240°F	S-W MATCH	1
010	52320S010	1/8	120-240°F	S-W MATCH	1
016	52320S016	1/4	120-240°F	S-W MATCH	2
017	52320S017	1/2	120-240°F	S-W MATCH	2
018	52320S018	3/8	120-240°F	S-W MATCH	2
60	52320S010	1/8	120-240°F	S-W MATCH	1
61	52320S004	1/4	120-240°F	S-W MATCH	1
62	52320S009	3/8	120-240°F	S-W MATCH	1
63	52320S003	1/2	120-240°F	S-W MATCH	1
230	IA96035*	1/8	50-200°F	S-W MATCH	1
15000	52320S004	1/4	120-240°F	S-W MATCH	1
15002	52320S016	1/4	120-240°F	S-W MATCH	2
15009	52320S017	1/2	120-240°F	S-W MATCH	2
15010	52320S003	1/2	120-240°F	S-W MATCH	1
15013	52320S009	3/8	120-240°F	S-W MATCH	1
15014	52320S018	3/8	120-240°F	S-W MATCH	2
96061	52320S010	1/8	120-240°F	S-W MATCH	1
OIL TEMPERATURE:					
002	52320S002	1/2	140-320°F	S-W MATCH	1
006	52320S006	1/8	140-320°F	S-W MATCH	1
007	52320S007	1/4	140-320°F	S-W MATCH	1
008	52320S008	3/8	140-320°F	S-W MATCH	1
96046	52320S006	1/8	140-320°F	S-W MATCH	1

* Use only with old style 50-200°F gauges. (Do not use with C-H or 120-240°F gauges.)

ohms. (These are single station values — twin station values would be 1/2 these numbers).

3. If sender is shorted (0 ohms) gauge will read above 240°F.
4. If sender has infinite resistance (Open) gauge will read below 120°F.
5. If the gauge reads lower than expected, was sealer used on the sender threads? (See illustration.)
6. The accuracy of the system (gauge, sender, voltage range) can vary as much as ±16° at 180°F.
7. Use of pipe extenders to plumb both a sender and temperature switch (for horn or warning light) from one port is not recommended. The amount of weight extended on the fitting of a vibrating engine could cause fatigue-related breakage. Also, the sender is removed from

water flow inside the engine and will probably read cooler.

8. Teleflex does not offer senders for metric threaded ports.
9. Dual Station installations:
 - a. When replacing one gauge in a two station installation, the second gauge may need to be replaced as well.
 - b. Mixing two gauges from different manufacturers to one sender may cause an error in both gauges.
 - c. If one gauge fails the second gauge will read much higher than expected.
 - d. If sender fails "open", both gauges will read below 120°F.
 - e. If sender fails "short", both gauges will read above 240°F.

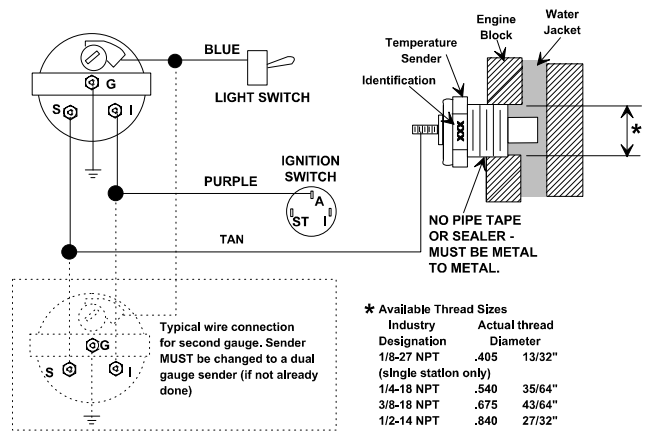

10. Twin engines: It may be helpful in troubleshooting to switch either the senders or the gauges from engine to engine.

Water Temperature Monitoring — Outboards

1. The temperature monitoring kit includes all parts to adapt to any of the situations noted above. Yamaha engines will require an adapter P/N 61886P in addition to the kit.
2. Outboard engines use raw water for cooling and are mostly aluminum, so they operate cooler than stern drives. Consult dealer or engine manual to determine maximum operating temperature of your engine.
3. The sender in the kit has 1/8-27 NPT threads with I.D. Code "10" or "60" stamped on the hex. Senders stamped "230" won't work correctly.
4. Part number of the sender is 52320S010; the flat bracket is 54552; the Z bracket IA55009.
5. Some engines include a threaded hole directly into a water line. The temperature sender can be threaded into the hole, using no sealant on the threads. The threads create the electrical ground.
6. Some engines have a blind threaded hole for a temperature sender that does not enter the water jacket. After applying thermal compound to the hole, thread the sender in snugly, again using no sealer.
7. Some Mercury engines have a blind hole flanked by two bolts. These are for tightening the flat plate. First place thermal compound in the hole, then drop the aluminum spacer in the hole. Thread sender into bracket over hole until it hits spacer.
8. The Z bracket installation is used most often as it fits any engine. The Z bracket through hole is held by any one of the engine's cylinder head bolts. The sender is threaded into the bracket's

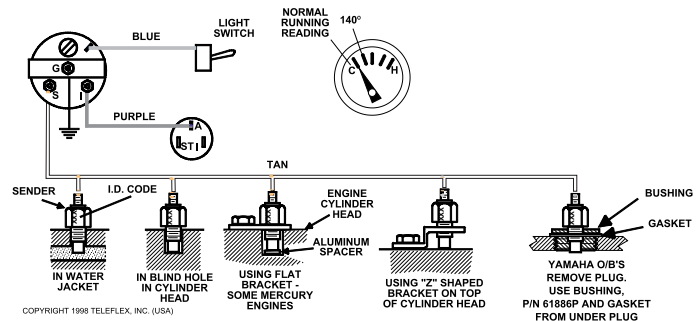

9. The kit is supplied with one sender. If a sender is desired on each cylinder bank on V type outboards, a double pole ON-ON switch must be used to switch sender input to the gauge. The gauge can not accurately handle two senders at one time.
10. Testing the gauge for operation: Connect a hot wire to "I" and ground wire to "G". Gauge should read below the C. Next, Short the "S" terminal to "G". The pointer should go above the H. If the pointer sweeps this way, the gauge is fine.
11. Testing the sender: At room temperature, with no wires on the sender, it should measure approximately .600-800 ohms on test meter.
12. Replacement outboard sender IA96035 cannot be used with this gauge. The gauge will read very high. IA96035 is only for pre-1995 Johnson®/Evinrude® engines with a 50-250°F gauge.